

1

B

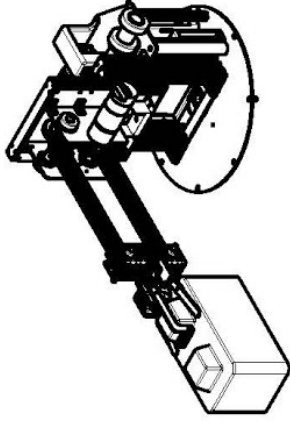

SCALE 1:10

2

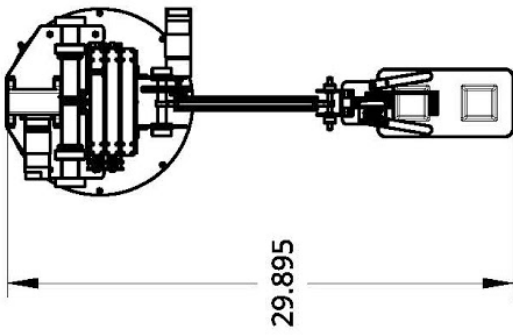

SCALE 1:10

B

A

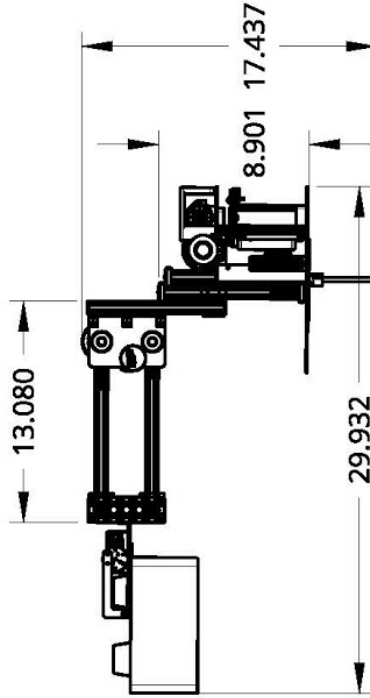

SCALE 1:10

SCALE 1:10

A

UNLESS OTHERWISE SPECIFIED, DIMENSIONS ARE IN INCHES		DATE	11/3/2019
DRAWN	DREW BUSCH	NAME	
CHECKED			
APPROVED			
DO NOT SCALE DRAWING		TITLE	
BREAK ALL SHARP EDGES AND REMOVE BURRS		Lift	
THIRD ANGLE PROJECTION		SIZE	A
		DWG NO.	RevRob-4
		SCALE	1:16
		WEIGHT	1 of 1

1

2

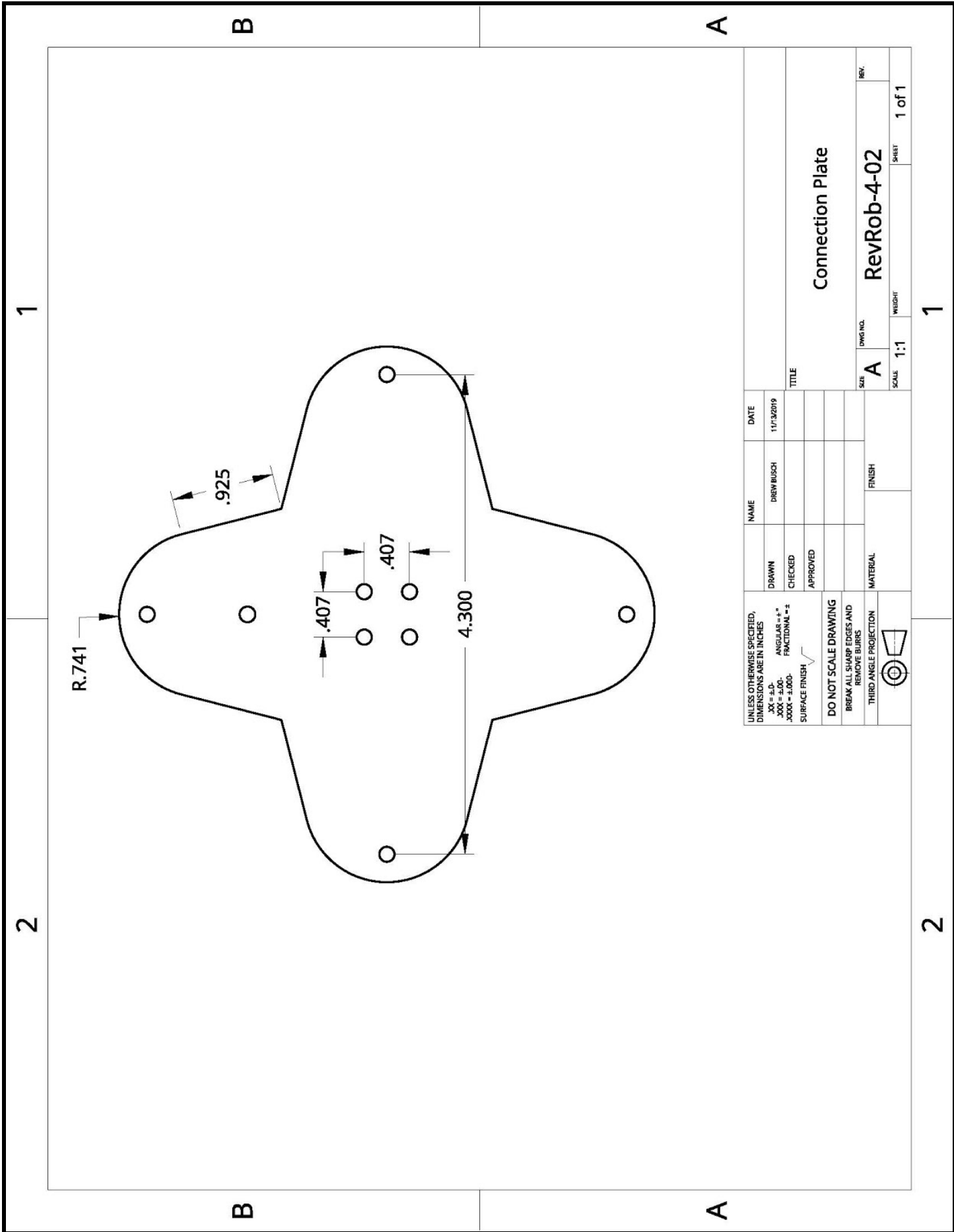

UNLESS OTHERWISE SPECIFIED, DIMENSIONS ARE IN INCHES XX = ±.01 XXX = ±.005 XXXX = ±.000		DATE	11/3/2019
DRAWN	NAME	DATE	11/3/2019
CHECKED	DREW BUSCH		
APPROVED			
SURFACE FINISH		TITLE	
DO NOT SCALE DRAWING		Connection Plate	
BREAK ALL SHARP EDGES AND REMOVE BURRS		SIZE	
THIRD ANGLE PROJECTION		A	
MATERIAL		DWG NO.	
		RevRob-4-02	
FINISH		SCALE	
		1:1	
		WEIGHT	
		1 of 1	
		REV.	

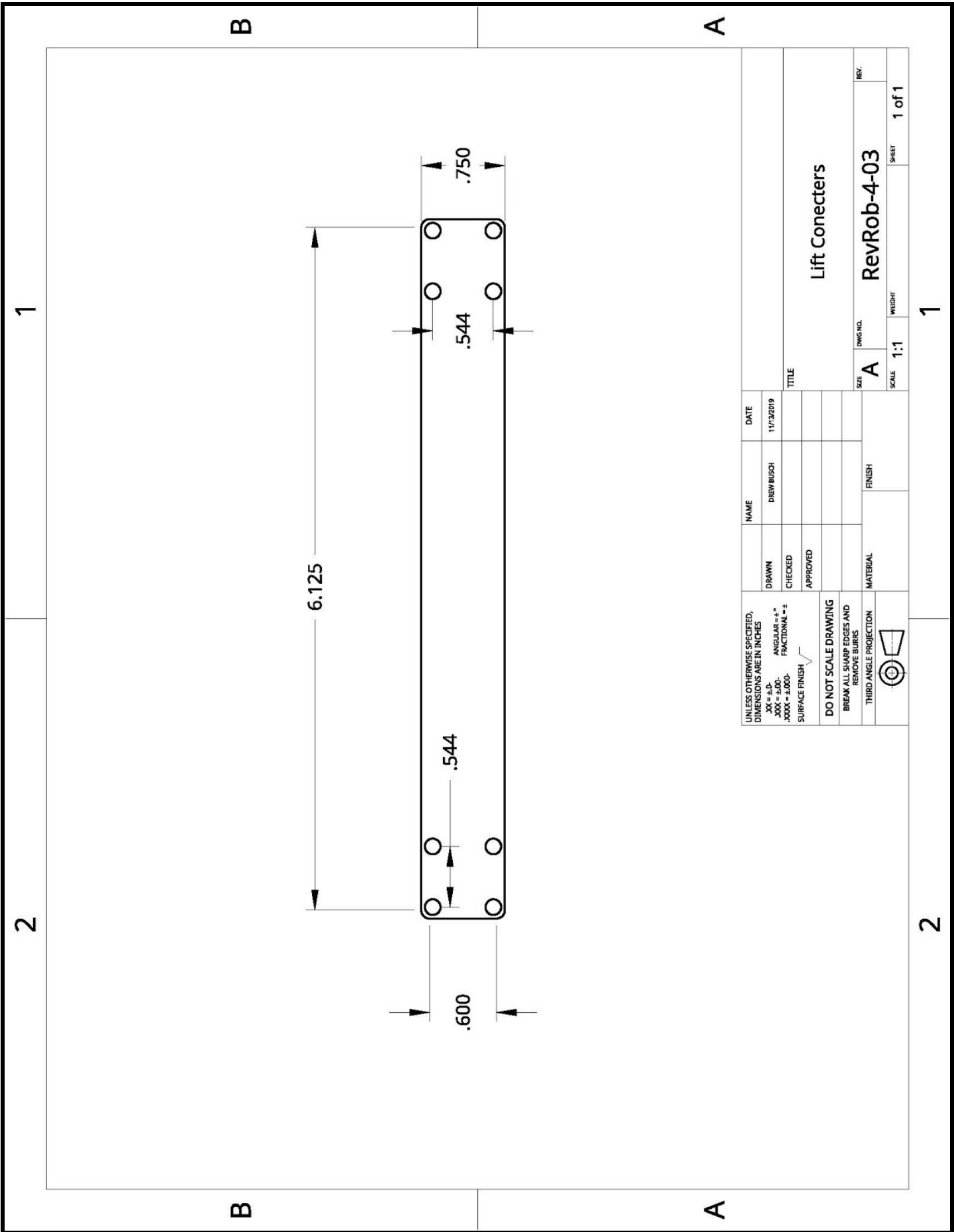

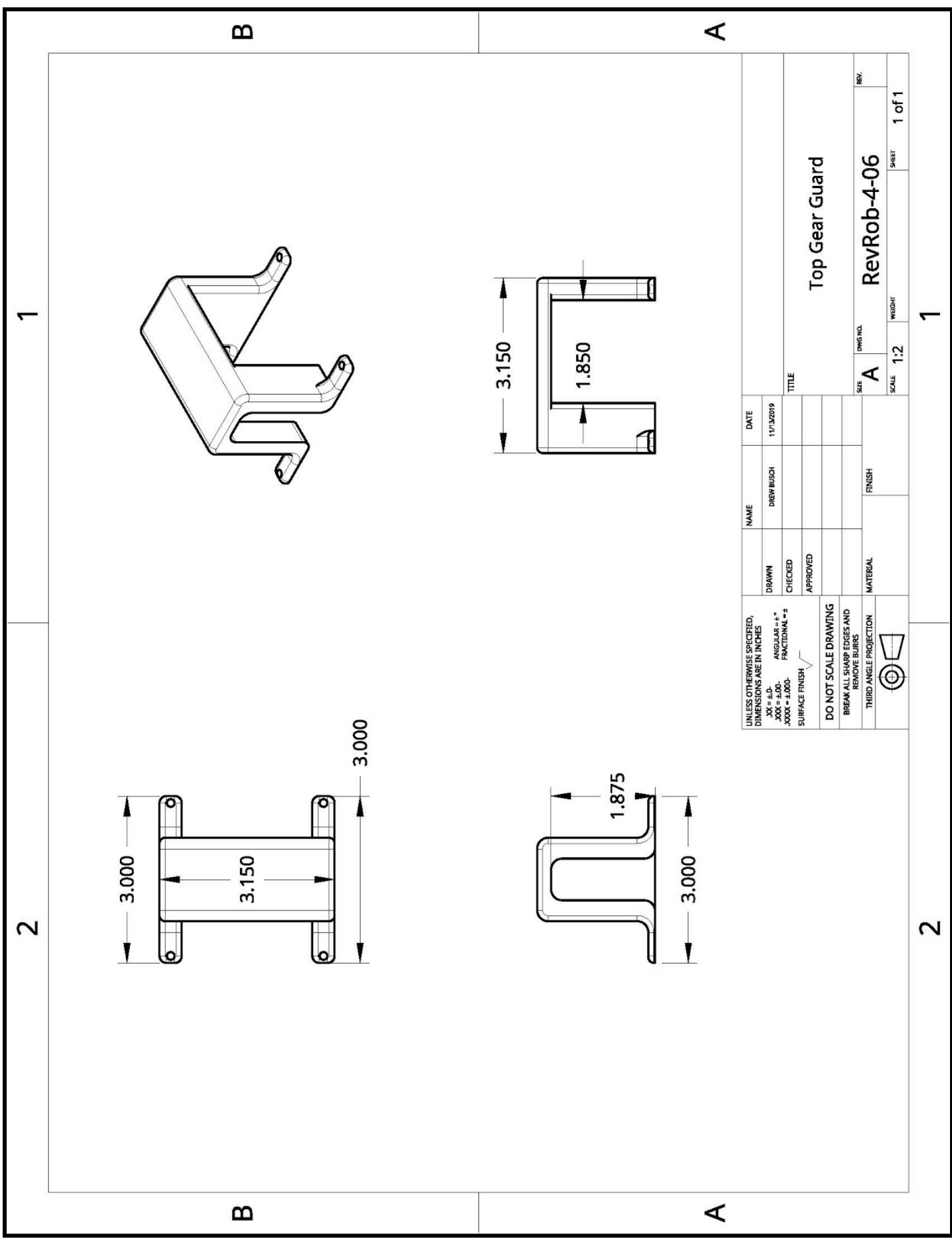

2

1

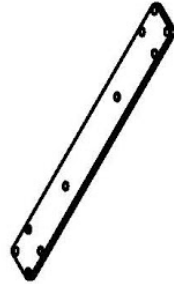
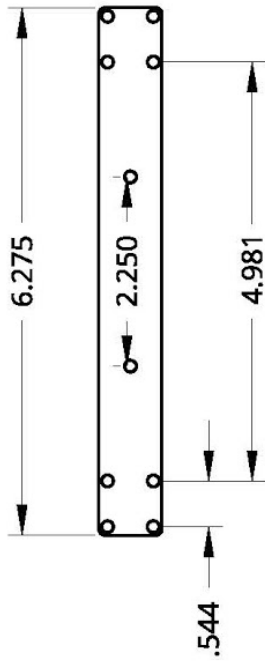

B

A

B

A

UNLESS OTHERWISE SPECIFIED, DIMENSIONS ARE IN INCHES .XX = ±.01 .XXX = ±.001 .XXXX = ±.0001 SURFACE FINISH		DATE	11/14/2019
DRAWN	NAME	DATE	11/14/2019
CHECKED	DREW BUSCH		
APPROVED			
DO NOT SCALE DRAWING BREAK ALL SHARP EDGES AND REMOVE BURRS		TITLE	
THIRD ANGLE PROJECTION		Camera Connector	
MATERIAL		SIZE	REV.
		A	RevRob-4-07
		DWG NO.	SHEET
		SCALE 1:3	1 of 1
		WEIGHT	

2

1

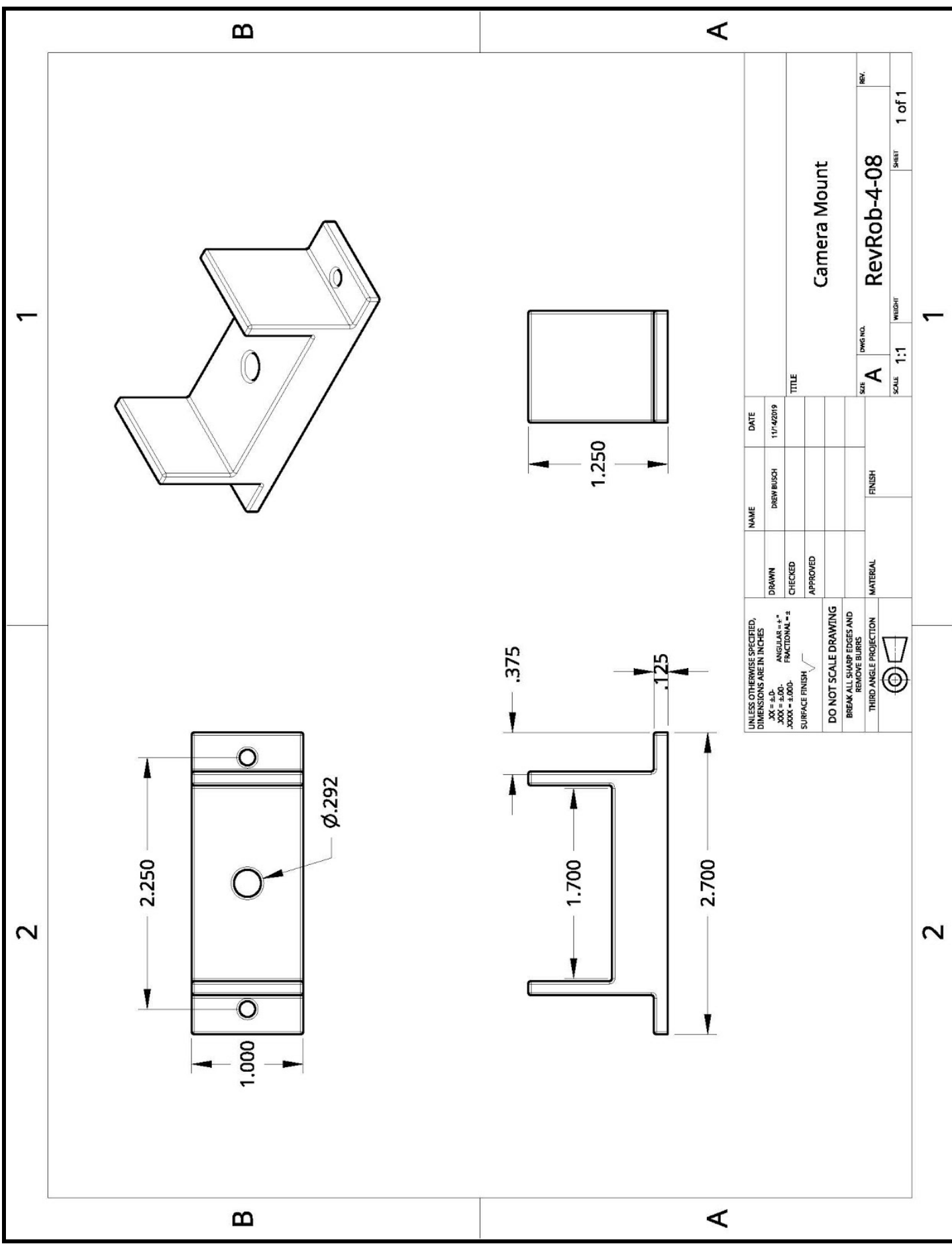

1

2

B

A

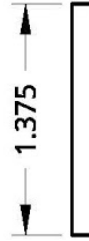
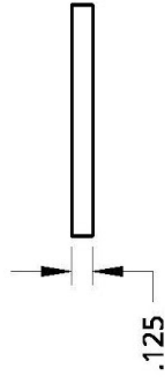
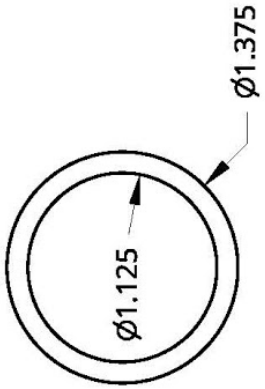
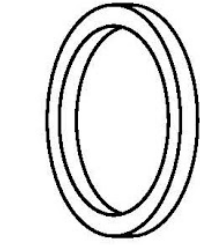

B

A

UNLESS OTHERWISE SPECIFIED, DIMENSIONS ARE IN INCHES .XX = ±.01- ANGULAR = ±° .XXX = ±.001- FRACTIONAL = ± .XXXX = ±.000- SURFACE FINISH		NAME	DATE	TITLE
DRAWN	DREW BUSCH	11/14/2019		
CHECKED				
APPROVED				
DO NOT SCALE DRAWING BREAK ALL SHARP EDGES AND REMOVE BURRS		MATERIAL	FINISH	
THIRD ANGLE PROJECTION				
SIZE	DWG NO.	REV.		
A		RevRob-4-09		
SCALE	1:1	WEIGHT	SHEET 1 of 1	

Pulley Spacer

1

2

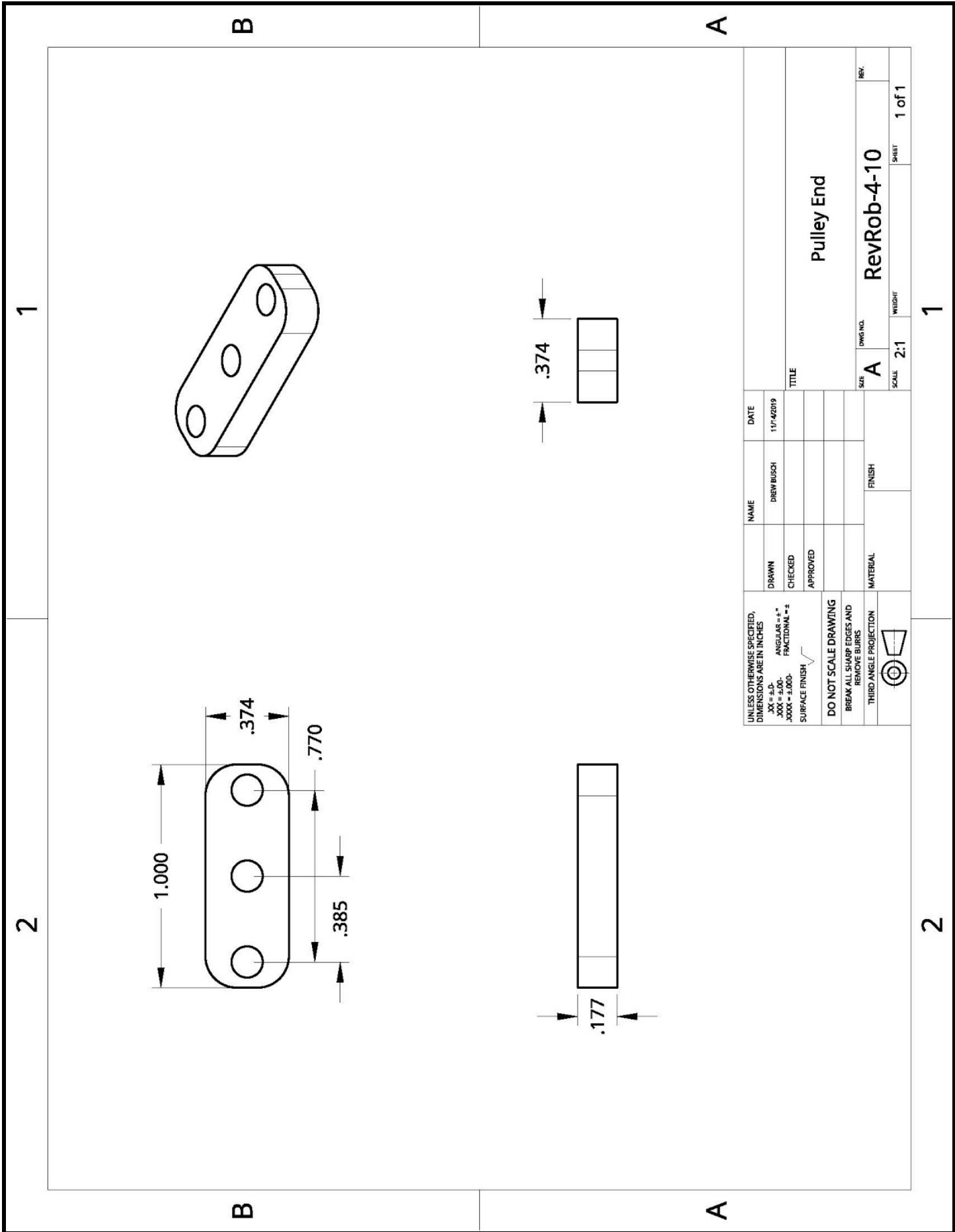

UNLESS OTHERWISE SPECIFIED, DIMENSIONS ARE IN INCHES		NAME	DATE
XX = ±.0	ANGULAR = ±°	DRAWN	11/4/2019
.XXX = ±.00	FRACTIONAL = ±	CHECKED	
.XXXX = ±.000		APPROVED	
SURFACE FINISH		TITLE	
DO NOT SCALE DRAWING		Pulley End	
BREAK ALL SHARP EDGES AND REMOVE BURRS		SIZE	
THIRD ANGLE PROJECTION		A	
		MATERIAL	DWG NO.
		FINISH	RevRob-4-10
		SCALE	1 of 1
		2:1	